



CE-2150-ABR



Camilla eléctrica para osteopatía de 7 secciones con respaldo reclinable en negativo. Incluye reposabrazos a la altura del respaldo regulables en altura y anchura, reposabrazos planos tapizados, portarrollos, tapón facial y ruedas escamoteables.

Electric couch for osteopathy of 7 sections with a negative adjustment of the backrest. It includes armrests next to the backrest with height and width regulation, upholstered flat armrests, a paper roll holder, a breathing hole plug and retractable wheels.

Table électrique pour l'ostéopathie en 7 plans avec dossier pro/déclive. Accoudoirs au dossier réglables en hauteur et en largeur, accoudoirs plats tapissés, porte-rouleaux, bouchon facial et roulettes escamotables compris.

Características generales	
Tipo de cabezal	Cabezal con agujero y tapón facial
Tipo de respaldo	Proclive/declive en negativo
Brazos	Reposabrazos a la altura del respaldo regulables en altura y anchura Reposabrazos planos abatibles
Piernas	Piecera (tercer cuerpo) elevable/reclinable
Otros extras incluidos	Agujero facial Mando de mano 1 Portarrollos camilla Tapón facial
Normativas y seguridad	El motor/motores cumplen con las normativas de seguridad europeas PRODUCTO CE Fabricado en España

Estructura y chasis	
Tipo de estructura	2 columnas
Peso soportado	180 kg
Material	Tubo de acero recubierto de polvo epoxi, cocido en horno a 210°C
Pintura	Blanco

Funcionalidades	
Tipo de motor	Eléctrico
Número de motores	1
Funcionalidades motorizadas	Altura
Funcionalidades mediante dos pistones de gas	Piecera (tercer cuerpo)
Funcionalidades mediante pistón de gas	Respaldo
Tipo de altura	Regulable
Otros	Respaldo abatible/reclinable

Ruedas	
Sistema de ruedas	Escamoteables mediante pedal único
Tipo de ruedas	Ruedas dobles de Ø 50mm

General features	
Type of headrest	Headrest with breathing hole and breathing hole plug
Type of backrest	Negative pro/declive position
Armrests	Armrests next to the backrest with height and width regulation Fold-down flat armrests
Leg section	Adjustable footrest (third section)
Other extra options included	Breathing hole Hand switch control 1 Paper roll holder Breathing hole plug
Rules and security	The engines meet the European safety regulation CE marking product. Made in Spain

Frame and chassis	
Type of frame	2 columns
Lifting capacity	180 kg
Material	Steel tube coated with an epoxy powder coating and oven-baked at 210°C
Paint	White

Functionalities	
Type of motor	Electric
Quantity of motors	1
Motorised functionalities	Height
Functionalities by two gas struts	Footrest (third section)
Functionalities by a gas strut	Backrest
Type of height	Adjustable
Others	Fold down and reclining headrest

Wheels	
Wheel system	Retractable by a single pedal
Type of wheels	Double wheels of Ø 50 mm

Caracteristiques generales	
Type de tête	Tête avec trou et bouchon facial
Type de dossier	Position pro/déclive en négatif
Accoudoirs	Accoudoirs au dossier réglables en hauteur et en largeur Accoudoirs plats repliables
Jambes	Repose-pieds (troisième plan) réglable
Extras supplémentaires compris	Trou visage Commande manuelle 1 Porte-rouleaux Bouchon facial
Normes et sécurité	Les moteurs se conforment aux normes de sécurité européennes Produit CE. Fabriqué en Espagne

Structure et châssis	
Type de structure	2 colonnes
Poids supporté	180 kg
Matériel	Châssis mécano soudé en acier. Finition: peinture poudre époxy cuite au four à 210°C
Peinture	Blanc

Fonctionnalités	
Type de moteur	Électrique
Nombre de moteurs	1
Fonctionnalités motorisées	Hauteur
Fonctionnalités par deux vérins à gaz	Repose-pieds (troisième plan)
Fonctionnalités par un vérin à gaz	Dossier
Type de hauteur	Réglable
Autres	Dossier escamotable et inclinable



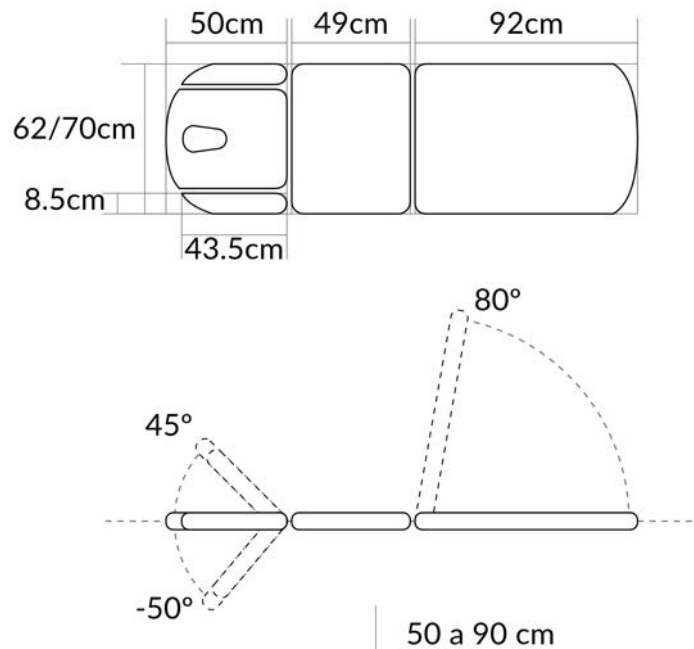

Roulettes	
Système de roulettes	Escamotables par une seule pédale
Type de roulettes	Roulettes doubles de Ø 50 mm







Espuma

					
E30/5 5cm 30Kg/m ³	E60/3 3cm 60Kg/m ³	E60/5 5cm 60Kg/m ³	E150/3 3cm 150Kg/m ³	E150/5 5cm 150Kg/m ³	E30/3+2V 3cm 30Kg/m ³ + 2cm visco
					
E30/5+2V 5cm 30Kg/m ³ + 2cm visco	E30/4+4V 4cm 30Kg/m ³ + 4cm visco	E30/5+4V 5cm 30Kg/m ³ + 4cm visco	E60/3+30/2 3cm 60Kg/m ³ + 2cm 30Kg/m ³	E60/2+30/5+4V 2cm 60Kg/m ³ + 5cm 30Kg/m ³ + 4cm visco	

Color estructura

			
ECB Blanca	ECG Gris plateado	ECA Antracita	ECN Negra

Mando

			
MM1 Mando de mano 1 motor	MP1 Mando de pie 1 motor	PERBO Periférico blanco omega	PERBL Periférico blanco lateral

Reposabrazos

				
BAT Brazos apoyo al terapeuta (2 unidades)	REX Reposabrazos extracción (tapizado acanalado)	REXROT Reposabrazos extracción con rótula (tapizado acanalado)	RP Reposabrazos plano tapizado	RAA Reposabrazos regulable en altura y apertura (tapizado)

Reposapiés

		
ESTR Estríberas	PG Juego perneras ginecológicas	PGR Juego perneras ginecológicas con rótula

Ruedas

SRE Sistema de ruedas escamoteables

Accesorios



PTB
Portarrollos base



PGOT
Palo de gotero



SB
Soportes genéricos (2 u.)



GNART
Goniómetro articulaciones



RE
Rulo enyesado



AF
Agujero facial



TF-01
Tapón facial



RSA
Respaldo sin agujero facial



CER
Cojín ergonómico respaldo
(sillones)



CAM
Cabezal acoplado madera

Foam



E30/5
5cm 30Kg/m³



E60/3
3cm 60Kg/m³



E60/5
5cm 60Kg/m³

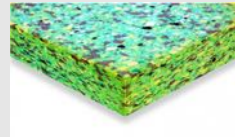

E150/3
3cm 150Kg/m³

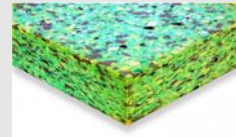

E150/5
5cm 150Kg/m³



E30/3+2V
3cm 30Kg/m³ + 2cm visco



E30/5+2V
5cm 30Kg/m³ + 2cm visco



E30/4+4V
4cm 30Kg/m³ + 4cm visco

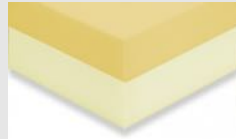

E30/5+4V
5cm 30Kg/m³ + 4cm visco

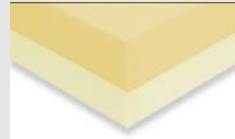

E60/3+30/2
3cm 60Kg/m³ + 2cm 30Kg/m³

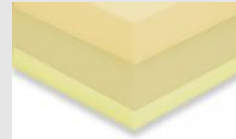

E60/2+30/5+4V
2cm 60Kg/m³ + 5cm 30Kg/m³ + 4cm visco

Structure colour



ECB
White



ECG
Silvered grey



ECA
Antracita



ECN
Black

Switch control



MM1
1 motor hand switch control



MP1
1 motor foot switch



PERBO
Omega white perimeter foot switch



PERBL
Lateral white perimeter foot switch

Armrests



BAT
Armrests for supporting the therapist (2 units)



REX
Phlebotomy armrests (fluted upholstery)



REXROT
Phlebotomy swivel armrests (fluted upholstery)



RP
Flat upholstered armrest



RAA
Adjustable height and angle armrest

Footrest



ESTR
Stirrups



PG
Set of gynaecological leg supports



PGR
Set of swivel gynaecological leg supports

Wheels



SRE
Retractable wheels system

Accessories



PTB
Paper roll holder at the base



PGOT
IV Pole



SB
Generic supports (2 u.)



GNART
Joint goniometer



RE
Plastering roll



AF
Breathing hole



TF-01
Breathing hole plug



RSA
Headrest without facial hole plug



CER
Ergonomic cushion for the
backrest



CAM
Coupled wooden headrest

Mousse

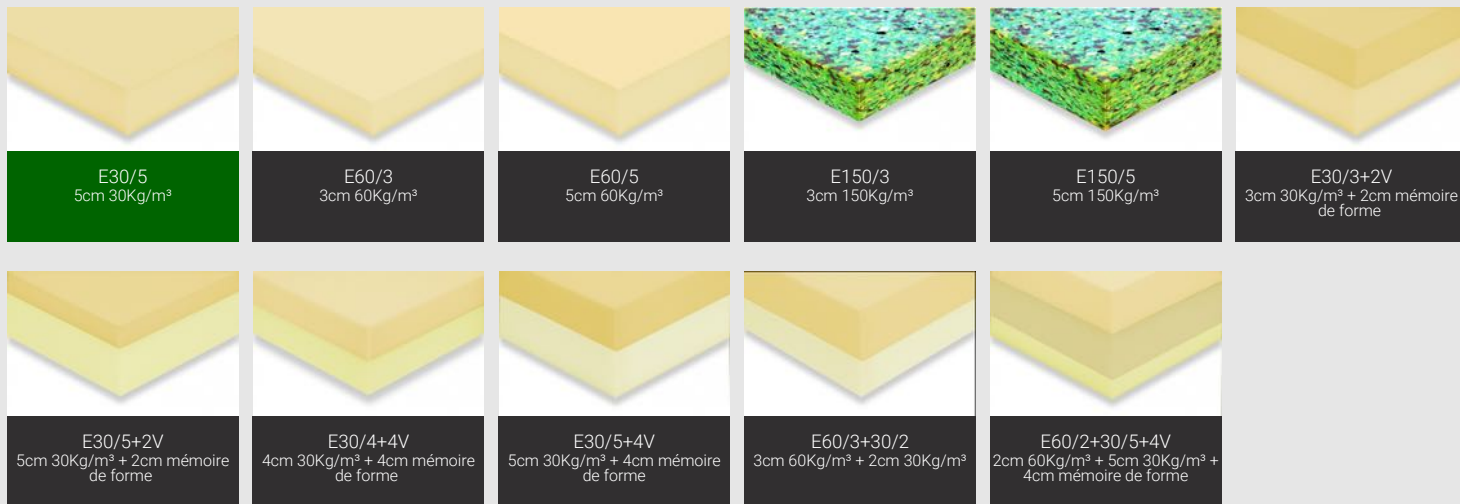

Couleur de la structure



Commande

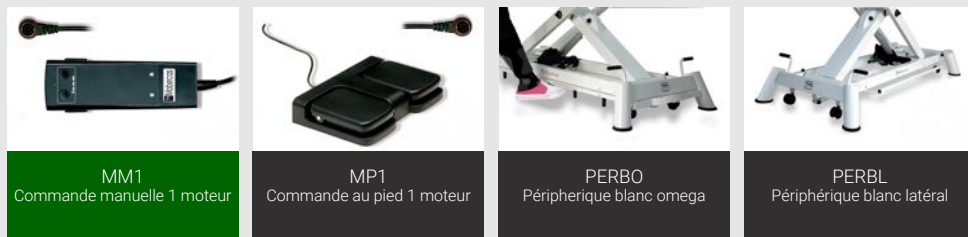

Accoudoirs



Repose-pieds



Roulettes



Accessoires



PTB
Porte-rouleaux à la base



PGOT
Tige à perfusion



SB
Étaux (2 u.)



GNART
Goniomètre pour les articulations



RE
Rouleau plâtré



AF
Trou visage



TF-01
Bouchon facial



RSA
Dossier sans trou visage



CER
Coussin ergonomique pour le dossier (fauteuils)



CAM
Tête en bois adaptable