



CE-0137-PC



Camilla de reconocimiento eléctrica de 3 secciones con pliegue central manual, subida recta sin desplazamiento lateral, portarrollos y tapón facial.

Electric examination couch of 3 sections with manual central fold, vertical elevation and no horizontal movements, a paper roll holder and a breathing hole plug.

Table d'examen électrique en 3 plans avec cyphose manuelle, montée à la verticale sans déplacement latéral, porte-rouleaux et bouchon facial.

Características generales	
Tipo de cabezal	Cabezal con agujero y tapón facial
Tipo de respaldo	Elevable/reclinable
Patas	4 niveladores ajustables para evitar los pequeños desniveles
Otros extras incluidos	Agujero facial
	Mando de mano 1
	Portarrollos camilla
	Tapón facial
Normativas y seguridad	El motor/motores cumplen con las normativas de seguridad europeas
	PRODUCTO CE Fabricado en España

Estructura y chasis	
Tipo de estructura	Tijera, con subida recta sin desplazamiento
Peso soportado	180 kg
Material	Tubo de acero recubierto de polvo epoxi, cocido en horno a 210°C
Pintura	Plata

Funcionalidades	
Tipo de motor	Eléctrico
Número de motores	1
Funcionalidades mediante palanca	Pliegue central
	Respaldo
Funcionalidades motorizadas	Altura
Tipo de altura	Regulable
Otros	Subida recta sin desplazamiento lateral

General features	
Type of headrest	Headrest with breathing hole and breathing hole plug
Type of backrest	Adjustable
Feet	4 adjustable feet for stability on uneven surfaces
Other extra options included	Breathing hole
	Hand switch control 1
	Paper roll holder
	Breathing hole plug
Rules and security	The engines meet the European safety regulation
	CE marking product. Made in Spain

Frame and chassis	
Type of frame	Scissor with vertical elevation and no movements
Lifting capacity	180 kg
Material	Steel tube coated with an epoxy powder coating and oven-baked at 210°C
Paint	Silver

Functionalities	
Type of motor	Electric
Quantity of motors	1
Functionalities by lever system	Central fold
	Backrest
Motorised functionalities	Height
Type of height	Adjustable
Others	Vertical elevation without horizontal movements

Caracteristiques generales	
Type de tête	Tête avec trou et bouchon facial
Type de dossier	Réglable
Pieds	4 patins réglables pour inégalités du sol
Extras supplémentaires compris	Trou visage
	Commande manuelle 1
	Porte-rouleaux Bouchon facial
Normes et sécurité	Les moteurs se conforment aux normes de sécurité européennes
	Produit CE. Fabriqué en Espagne

Structure et châssis	
Type de structure	Ciseaux avec montée à la vertical sans déplacement
Poids supporté	180 kg
Matériel	Châssis mécano soudé en acier. Finition: peinture poudre époxy cuite au four à 210°C
Peinture	Argent

Fonctionnalités	
Type de moteur	Électrique
Nombre de moteurs	1
Fonctionnalités par système de leviers	Cyphose
	Dossier
Fonctionnalités motorisées	Hauteur
Type de hauteur	Réglable
Autres	Montée à la verticale sans déplacement latéral

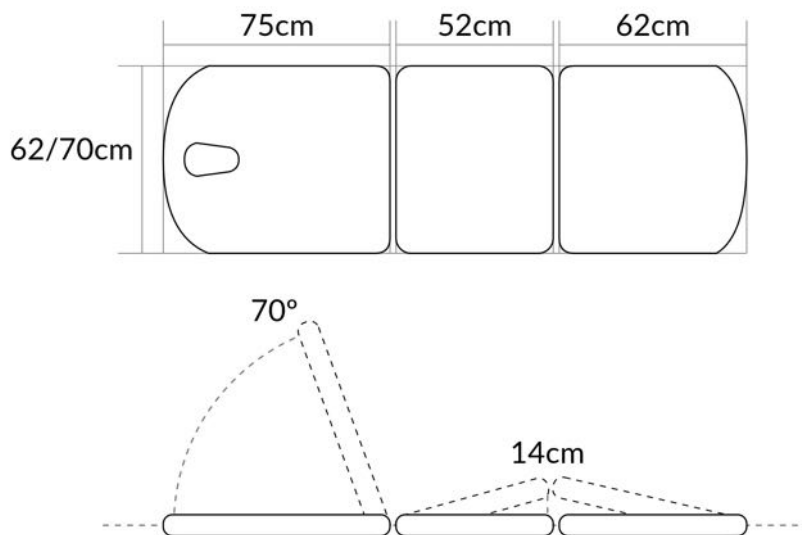

54 a 100 cm





Espuma

					
<b>E30/5</b> 5cm 30Kg/m <sup>3</sup>	<b>E60/3</b> 3cm 60Kg/m <sup>3</sup>	<b>E60/5</b> 5cm 60Kg/m <sup>3</sup>	<b>E150/3</b> 3cm 150Kg/m <sup>3</sup>	<b>E150/5</b> 5cm 150Kg/m <sup>3</sup>	<b>E30/3+2V</b> 3cm 30Kg/m <sup>3</sup> + 2cm visco
					
<b>E30/5+2V</b> 5cm 30Kg/m <sup>3</sup> + 2cm visco	<b>E30/4+4V</b> 4cm 30Kg/m <sup>3</sup> + 4cm visco	<b>E30/5+4V</b> 5cm 30Kg/m <sup>3</sup> + 4cm visco	<b>E60/3+30/2</b> 3cm 60Kg/m <sup>3</sup> + 2cm 30Kg/m <sup>3</sup>	<b>E60/2+30/5+4V</b> 2cm 60Kg/m <sup>3</sup> + 5cm 30Kg/m <sup>3</sup> + 4cm visco	

Color estructura

			
<b>ECB</b> Blanca	<b>ECG</b> Gris plateado	<b>ECA</b> Antracita	<b>ECN</b> Negra

Mando

			
<b>MM1</b> Mando de mano 1 motor	<b>MP1</b> Mando de pie 1 motor	<b>PERG7</b> Periférico gama 7	<b>PERG7L</b> Periférico gama 7 lateral

Reposabrazos

				
<b>BAT</b> Brazos apoyo al terapeuta (2 unidades)	<b>REX</b> Reposabrazos extracción (tapizado acanalado)	<b>REXROT</b> Reposabrazos extracción con rótula (tapizado acanalado)	<b>RP</b> Reposabrazos plano tapizado	<b>RAA</b> Reposabrazos regulable en altura y apertura (tapizado)

Reposapiés

		
<b>ESTR</b> Estriberas	<b>PG</b> Juego perneras ginecológicas	<b>PGR</b> Juego perneras ginecológicas con rótula

Ruedas

			
<b>RF50</b> Ruedas dobles con freno individual Ø50mm (x4)	<b>RF100</b> Ruedas dobles con freno individual Ø100mm (x4)	<b>RF125</b> Ruedas con freno individual Ø125mm (x4)	<b>RF200</b> Ruedas con freno individual Ø200mm (x4)

## Accesorios



PT  
Portarrollos



PGOT  
Palo de gotero



BD  
Barandillas



SB  
Soportes genéricos (2 u.)



GUILAT1  
Guías laterales 126cm



GNART  
Goniómetro articulaciones



RE  
Rulo enyesado



AF  
Agujero facial



TF-01  
Tapón facial



RSA  
Respaldo sin agujero facial





CER  
Cojín ergonómico respaldo  
(sillones)







CAM  
Cabezal acoplado madera





Foam

					
E30/5 5cm 30Kg/m <sup>3</sup>	E60/3 3cm 60Kg/m <sup>3</sup>	E60/5 5cm 60Kg/m <sup>3</sup>	E150/3 3cm 150Kg/m <sup>3</sup>	E150/5 5cm 150Kg/m <sup>3</sup>	E30/3+2V 3cm 30Kg/m <sup>3</sup> + 2cm visco
					
E30/5+2V 5cm 30Kg/m <sup>3</sup> + 2cm visco	E30/4+4V 4cm 30Kg/m <sup>3</sup> + 4cm visco	E30/5+4V 5cm 30Kg/m <sup>3</sup> + 4cm visco	E60/3+30/2 3cm 60Kg/m <sup>3</sup> + 2cm 30Kg/m <sup>3</sup>	E60/2+30/5+4V 2cm 60Kg/m <sup>3</sup> + 5cm 30Kg/m <sup>3</sup> + 4cm visco	



Structure colour

			
ECB White	ECG Silvered grey	ECA Antracita	ECN Black



Switch control

			
MM1 1 motor hand switch control	MP1 1 motor foot switch	PERG7 7 range perimeter foot switch	PERG7L 7 range lateral perimeter foot switch

Armrests

				
BAT Armrests for supporting the therapist (2 units)	REX Phlebotomy armrests (fluted upholstery)	REXROT Phlebotomy swivel armrests (fluted upholstery)	RP Flat upholstered armrest	RAA Adjustable height and angle armrest

Footrest

		
ESTR Stirrups	PG Set of gynaecological leg supports	PGR Set of swivel gynaecological leg supports

Wheels

			
RF50 Double wheels with individual breaks Ø50mm (x4)	RF100 Double wheels with individual breaks Ø 100 mm (x4)	RF125 Wheels with individual breaks Ø 125 mm (x4)	RF200 Wheels with individual breaks Ø 200 mm (x4)

## Accessories



PT  
Paper roll holder



PGOT  
IV Pole



BD  
Side support rails



SB  
Generic supports (2 u.)



GUILAT1  
Lateral guides 126cm



GNART  
Joint goniometer



RE  
Plastering roll



AF  
Breathing hole



TF-01  
Breathing hole plug



RSA  
Headrest without facial hole plug







CER  
Ergonomic cushion for the  
backrest



CAM  
Coupled wooden headrest

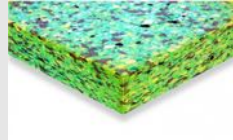
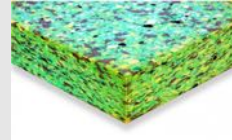

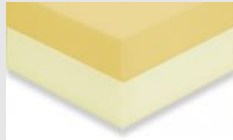

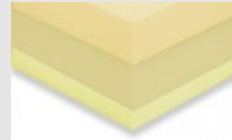

Mousse

					
<b>E30/5</b> 5cm 30Kg/m <sup>3</sup>	<b>E60/3</b> 3cm 60Kg/m <sup>3</sup>	<b>E60/5</b> 5cm 60Kg/m <sup>3</sup>	<b>E150/3</b> 3cm 150Kg/m <sup>3</sup>	<b>E150/5</b> 5cm 150Kg/m <sup>3</sup>	<b>E30/3+2V</b> 3cm 30Kg/m <sup>3</sup> + 2cm mémoire de forme
					
<b>E30/5+2V</b> 5cm 30Kg/m <sup>3</sup> + 2cm mémoire de forme	<b>E30/4+4V</b> 4cm 30Kg/m <sup>3</sup> + 4cm mémoire de forme	<b>E30/5+4V</b> 5cm 30Kg/m <sup>3</sup> + 4cm mémoire de forme	<b>E60/3+30/2</b> 3cm 60Kg/m <sup>3</sup> + 2cm 30Kg/m <sup>3</sup>	<b>E60/2+30/5+4V</b> 2cm 60Kg/m <sup>3</sup> + 5cm 30Kg/m <sup>3</sup> + 4cm mémoire de forme	

Couleur de la structure

			
<b>ECB</b> Blanche	<b>ECG</b> Grise	<b>ECA</b> Anthracite	<b>ECN</b> Noir

Commande

			
<b>MM1</b> Commande manuelle 1 moteur	<b>MP1</b> Commande au pied 1 moteur	<b>PERG7</b> Périphérique gamme 7	<b>PERG7L</b> Phériphérique latéral gamme 7

Accoudoirs

				
<b>BAT</b> Bras de soutien pour le thérapeute (2 unités)	<b>REX</b> Accoudoirs pour l'extraction de sang (tapisserie ondulé)	<b>REXROT</b> Accoudoirs articulés pour l'extraction de sang (tapisserie ondulé)	<b>RP</b> Accoudoirs plats tapissés	<b>RAA</b> Accoudoir réglable en hauteur et en ouverture

Repose-pieds

		
<b>ESTR</b> Étriers	<b>PG</b> Jeu de repose-jambes gynécologiques	<b>PGR</b> Jeu de repose-jambes gynécologiques et articulés

Roulettes

			
<b>RF50</b> Roulettes doubles avec frein individuel Ø50mm (x4)	<b>RF100</b> Roulettes doubles avec frein individuel Ø 100 mm (x4)	<b>RF125</b> Roulettes avec frein individuel Ø 125 mm (x4)	<b>RF200</b> Roulettes avec frein individuel Ø 200 mm (x4)

## Accessoires



PT  
Porte-rouleaux



PGOT  
Tige à perfusion



BD  
Barrières de sécurité



SB  
Étaux (2 u.)



GUILAT1  
Guides latéraux 126cm



GNART  
Goniomètre pour les articulations



RE  
Rouleau plâtré



AF  
Trou visage



TF-01  
Bouchon facial



RSA  
Dossier sans trou visage



CER  
Coussin ergonomique pour le dossier (fauteuils)



CAM  
Tête en bois adaptable